

Temperature and Humidity Module

2012-7-2

Version: 1.4

- .Four Pins interface port
- .Wide range Temperature and Relative humidity.
- .Ultra low power consumption
- . Low cost .
- . Small size.

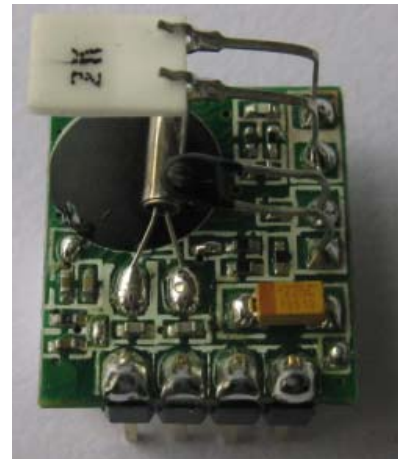

Description

The TH01 module is based on one 8-bit MCU, NTC temperature and humidity sensor to measure the environment atmosphere temperature and humidity. With two lines interface can be directly read out the temperature and humidity value, the application is simple for user to access the real temperature and humidity reading.

TH01 module is in stop mode after measure the atmosphere and humidity.

Features

- Humidity Range: 20% - 99%
- .Temperature Measure Range:-50°C- 70°C.
- .Module Operations Temperature Range: -40°C- 85°C
- . Similar I²C Serial Interface
- . Voltage Provide Range: 2.6V~5.0V

Applications

- .Consumer Products
- .Weather Stations
- . Humidifiers
- . Temperature controller
- . Store

Block Diagram

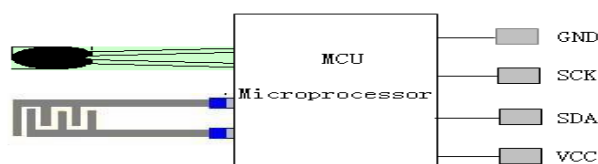

App1 Temperature -20°C~70°C

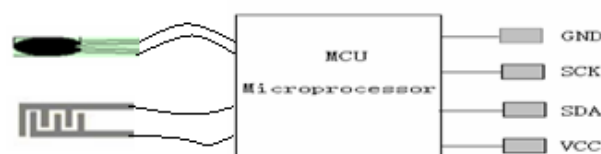

App2 Temperature -50°C~70°C

Temperature and Humidity Module

2012-7-2

Version: 1.4

Recommended Operating Conditions

Item		Voltage	Unit	Minimum	Typical Value	Maximum
1. Supply voltage			V	2.6	3	5
2. A Mode	Standby Current	3V	uA	---	1	3
	Working Current		mA	---	0.7	1.2
3. B Mode	Standby Current	3V	uA	---	4	8
	Working Current		mA	---	0.7	1.2
4. A Mode	Standby Current	4V	uA	---	1	3
	Working Current		mA	---	1.5	2.5
5. B Mode	Standby Current	4V	uA	---	10	14
	Working Current		mA	---	1.5	2.5
6. A Mode	Standby Current	4.5V	uA	---	1	3
	Working Current		mA	---	2.2	3
7. B Mode	Standby Current	4.5V	uA	---	14	18
	Working Current		mA	---	2.2	3
14. Outdoor Measuring Range						
①: -20℃~70℃			℃	-20	---	70
②: -50℃~ 70℃				-50	---	70
15. Temperature Resolution		---	℃	---	0.1	---
16. Indoor temperature accuracy						
①: 0℃~40℃			℃	-1	---	1
②: -50℃~0℃ , 40℃~70℃(without 40℃)			℃	-1.5	---	1.5
17. Humidity range		---	%	20	---	99
18. Humidity Accuracy (at 25℃)						
①. 40%~80%			%	-5	-	5
②. 30%~40% ,80%~90%				-8	-	8
③. 20%~30%, 90%~99%				N/A	---	N/A

Typical Application Circuit Diagram:

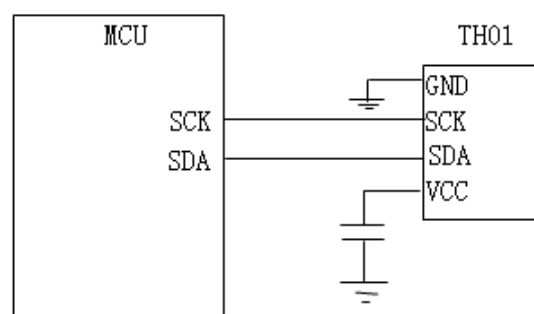

Pin Function Descriptions .

Temperature and Humidity Module

2012-7-2

Version: 1.4

Pin Name	Pin	Type	Function
GND	1	G	Power Ground
SCK	2	I	I ² C clock input
SDA	3	I/O	I ² C data input and output
VCC	4	P	power VCC

NOTE:

1. The TH01 App temperature under 0°C, the humidity data will keep the last temperature >0°C data, The humidity sensor will stop work.

2. The TH01 App temperature less than -20°C, The temperature sensor need change to the out induce, The humidity function will cancel, Because the TH01 32.768khz only working >-20 °C .Working <-20 the error will too large.

A MODE

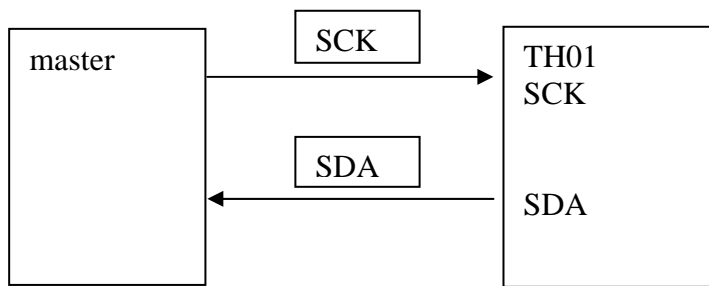

Data Format

byte1	byte2	byte3	byte4
tempH	tempL	humi*	crc

Byte1 to Byte4 are Hex format

Temperature data scale 10 then original data.

Negative temperature is complement code

TH01 module can option without humidity, at this

Case this byte will fix 0x00

B MODE

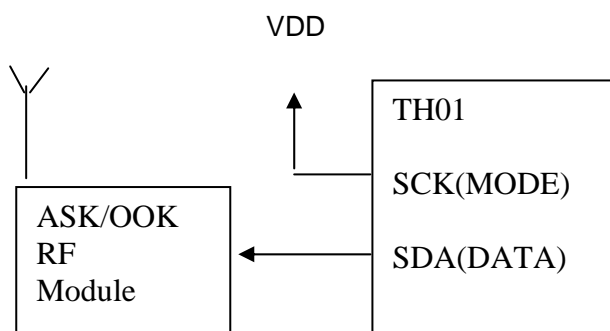

Temperature and Humidity Module

2012-7-2

Version: 1.4

SCK pin is pull up with internal pull-up resistor.

SYN+CODE(data format)
RF
CODE H/L(US)
0 488/488±20
1 488/1952±50
SYN 488/6958±50

TH01 with two mode

A or B mode Option

TH01 power on after 1 second start to detect the SCK PIN level

PIN level is high; it will work in B mode. SCK pin level must be set high after set mode, At least 3seconds the user can be read data, When in mode A it should be at least 2 seconds interval between two reads. In mode B, each time SCK pin level changed, TX cycle will reset and TX after 60s.After power up and set mode, A mode will directly enter sleep, B mode will enter low power consumption mode after once TX.

A mode

Communication Step

1. Master output the falling edge signal keep this low level for 500ms to 5 seconds on SCK PIN.
2. Master output one dummy clock which high level pulse width will over 1ms.
3. Master output the clock in its fix rate to get each bit data.
4. When SCK at high, the SDA data is stable. The clock rate is from 5k to 100kbps.
5. Data is 4 bytes, 3 bytes data, and 1 byte CRC checksum.
6. Each byte is the MSB first out.

A mode Timing

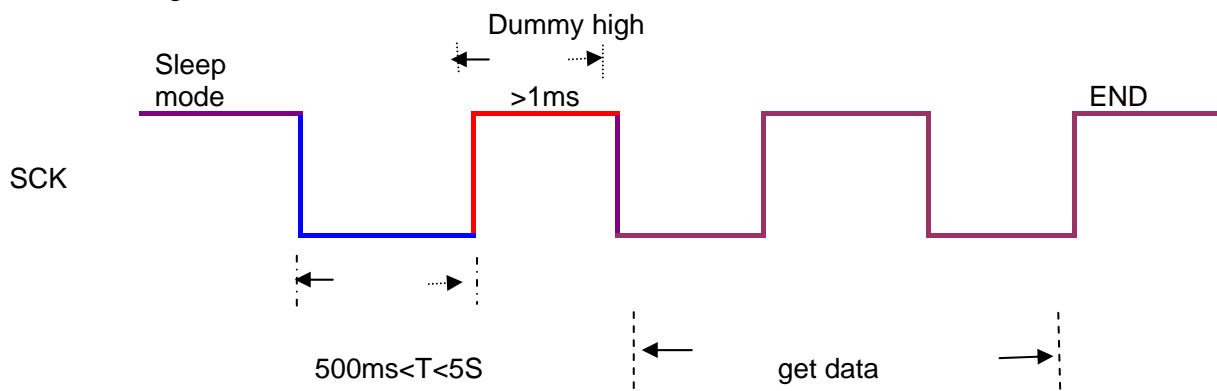

Set_SCK //Before enter sleep mode

Temperature and Humidity Module

2012-7-2

Version: 1.4

```
sleep();           //sleep
Clr_SCK();        //falling edge to wakeup TH01
delay_ms(500);    //Low level keep between 500ms and 5 seconds
Set_SCK();        //send_dummy_clock

delay_ms(1);      //dummy high keep >1ms

start_rec_data    //After dummy start the get out data by each clock
```

B mode

Function

1. Simple Transmitter ASK or OOK.
2. SCK PIN=high, TH01 will auto transmit data by 60 seconds period.
3. Each RF time it will transmit five bytes preamble code followed by five same frames data. Each frame data format is "SYN + A mode data format". So each RF time is 168ms~403ms.
4. Any time SCK PIN=high will repeat step2.

RF transmit circle

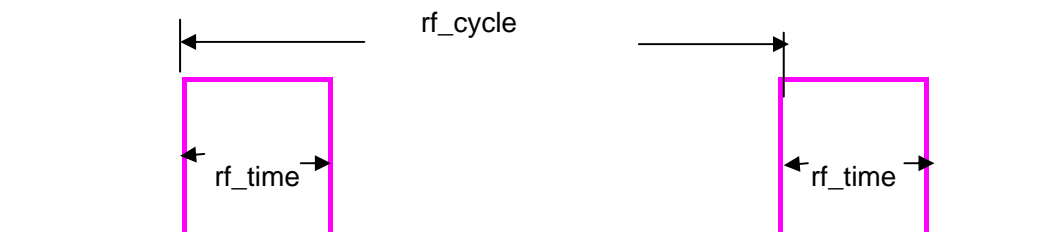

Five same frames
 $168\text{ms} < \text{rf_time} < 403\text{ms}$
 $\text{rf_cycle} = 60\text{s}$

B mode bit format

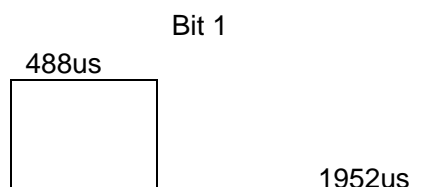

Temperature and Humidity Module

2012-7-2

Version: 1.4

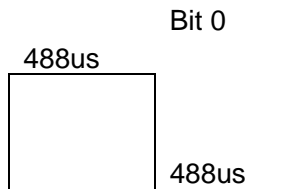

8bit crc algorithm

```
byte crc_algorithm(void)
{
    byte i,j,crc_checksum = 0xff;
    byte data_buf[3]={TEMP_DATA_H,TEMP_DATA_L,HUMI_DATA};

    for (i = 0 ;i < 3 ; i++)
    {
        crc_checksum ^= data_buf[i];
        for(j = 0 ; j < 8 ; j++)
        {
            if (crc_checksum & 0x01)
            {
                crc_checksum >>= 1;
                crc_checksum ^= 0x8c;
            }
            else
            {
                crc_checksum >>= 1;
            }
        }
    }
    return(crc_checksum);
}
```

Temperature and Humidity Module

2012-7-2

Version: 1.4

TH01 Mechanical Dimension .

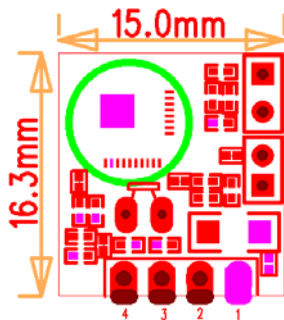

(Top View)

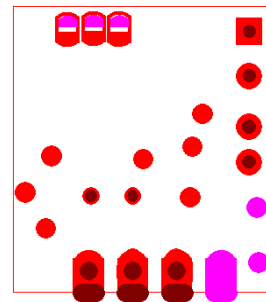

(Bottom View)

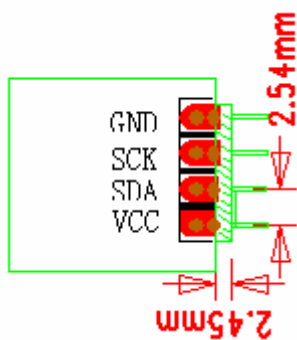

(DIP Type)

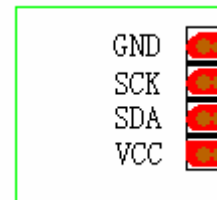

(SMD Type)

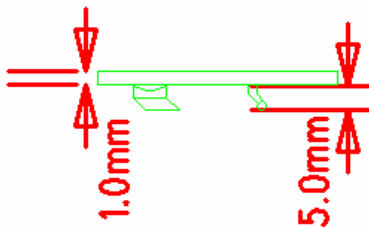

(Thickness)

Importance Note:

HopeRF will change the datasheet without any user permission, but we will update the newest datasheet into our web size, so please keep the checking.

<http://www.hoperf.com>